



















WHEEL CHANGING SAFETY

Before raising the vehicle, or changing a wheel make sure that you read, and comply with the following warnings.

-  Always find a safe place to stop, off the highway and away from traffic.
-  Make sure that the vehicle and jack are both on firm level ground.
-  Apply the parking brake, and engage Park (P).
-  Switch on the hazard warning lamps.
-  Make sure that the front wheels are in the straight ahead position, and engage the steering lock.
-  Make sure that all passengers, and animals, are out of the vehicle and in a safe place away from the highway.
-  Place a warning triangle at a suitable distance behind the vehicle, facing towards oncoming traffic.
-  When one rear wheel is lifted off the ground the selection P (Park) position will not prevent the vehicle from moving and possibly slipping off the jack as the park brake only operates on the rear wheels. Use the wheel chock when jacking the vehicle.
-  Always chock the wheel diagonally opposite the wheel to be changed, using the wheel chock supplied in the tool kit. Chock the front of a front wheel, or the rear of a rear wheel.
-  If jacking the vehicle on a slight slope is unavoidable, place chocks on the downhill side of the two opposite wheels. An additional chock will be needed.

-  Never place anything between the jack and the ground, or the jack and the vehicle.
-  Do not attempt to raise the vehicle unless the jack head is fully engaged in the jacking point. Only jack the vehicle using the approved jacking points.
-  Remove the spare wheel prior to jacking the vehicle, to avoid destabilising the vehicle when raised.
-  Take care when lifting the spare wheel, and removing the punctured wheel. The wheels are heavy, and can cause injuries if not handled correctly.
-  Do not start or run the engine while the vehicle is supported only by a jack.
-  **WARNING - THAT NO PERSON SHOULD PLACE ANY PORTION OF THEIR BODY UNDER A VEHICLE THAT IS SUPPORTED BY A JACK.**
-  Take care when loosening the wheel nuts. The wheel brace may slip off if not properly attached, and the wheel nuts may release suddenly. Either unexpected movement may cause an injury.
-  After use, the tool kit should be returned to the under floor storage area and correctly stowed.
-  Always make sure replacement tyres have the correct rating and specifications (e.g. load index, size, speed rating) for your vehicle.

Wheel changing

WHEEL CHANGING

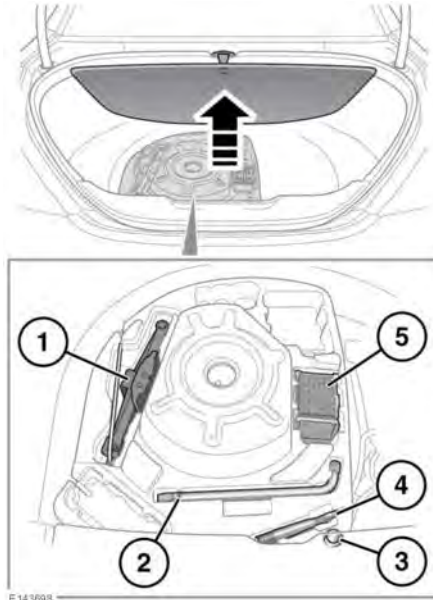

1. Jack: Observe the instructions printed on the jack.
2. Wheel brace.
3. Locking wheel nut adaptor.
4. Towing eye.
5. Wheel chock.

To remove the spare wheel, unscrew and remove the bolt through the centre.

Before raising the vehicle slacken but do not remove the wheel nuts.

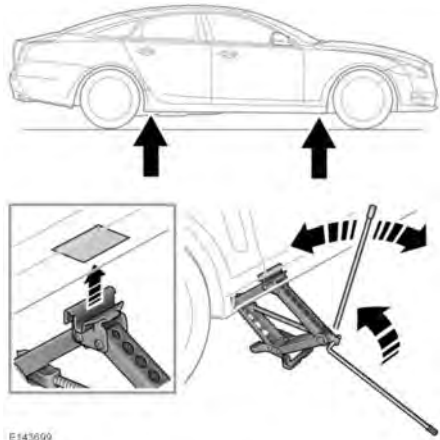

E143699

There are four jacking points on the underside of the floor. Two indented, triangular indicators are provided on each sill cover. These indicate the location for the jack.

Carefully raise the vehicle by turning the jack handle. Stop jacking the vehicle when the tyre just clears the ground. Minimum tyre lift gives maximum vehicle stability.

Note: To remove the centre badge use the plastic tipped end of the wheel nut wrench handle, push the centre badge from its housing from the inside of the wheel.

Using the wheel nut wrench, lightly tighten the wheel nuts alternately using the sequence shown in the illustration.

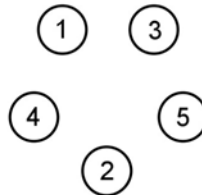

E132675

Lower the jack, then tighten the wheel nuts fully, in the same sequence shown. Do not overtighten by using foot pressure or extension bars on the wheel nut wrench.

At the earliest opportunity have the wheel nuts tightened with a torque wrench to 125 Nm (92 lb.ft).

This torque must not be exceeded.

LOCKING WHEEL NUTS

Locking wheel nuts can be removed and installed using only the special adapter provided in the tool kit.

Note: When the vehicle is first supplied, the adapter may be stored in the glove compartment. It should be removed and stored in the tool kit as soon as possible.

Note: A code number is stamped onto the underside of the adapter. This number should be recorded in the Service Record and Warranty Benefits supplied with the literature pack. If a replacement adapter is required, you will be asked to quote this number.

IMPORTANT – USE OF SPARE TYRE

Observe the following warnings before using the temporary spare wheel:



Adhere to the instructions on the temporary spare warning label, affixed to the wheel. Failure to do so may cause vehicle instability and/or tyre failure.



Where fitted the temporary use spare wheel is FOR TEMPORARY USE ONLY. Drive with caution while the temporary spare wheel is fitted. Ensure that an original size wheel and tyre are fitted as soon as possible.



Do not fit more than one temporary spare wheel to the vehicle at any one time.



Do not exceed 80 km/h (50 mph) while the temporary spare wheel is fitted.



The tyre pressure in the temporary spare wheel should be 4.2 bar (60 psi/420 kPa).



DSC must be switched on while the temporary spare wheel is in use.



Traction devices such as snow chains cannot be used with a temporary spare wheel.