

Wheels and tyres

GENERAL INFORMATION

Tyre markings

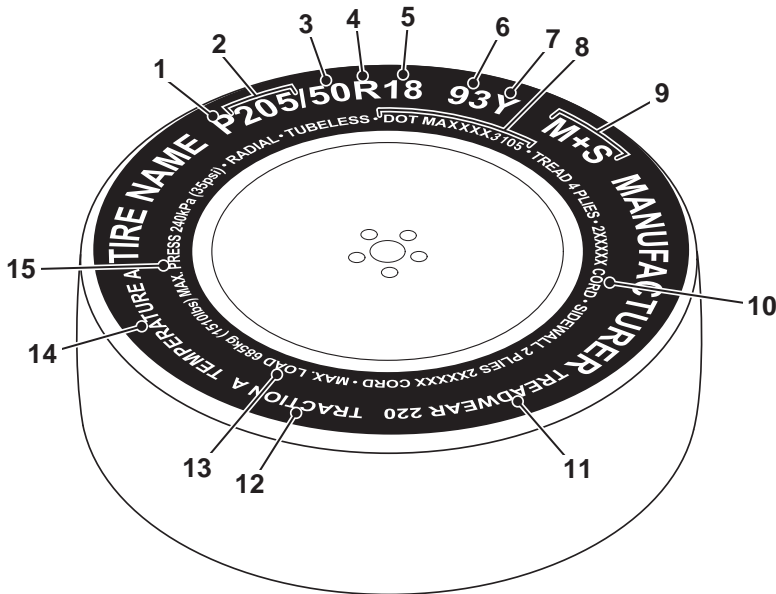

JAG1525

1. P indicates that the tyre is for passenger vehicle use.
2. The width of the tyre from sidewall edge to sidewall edge in millimetres.
3. The aspect ratio, also known as the profile, gives the sidewall height as a percentage of the tread width. So, if the tread width is 205 mm, and the aspect ratio is 50, the sidewall height will be 102 mm.
4. R indicates that the tyre is of Radial ply construction.
5. The diameter of the wheel rim given in inches.
6. The load index for the tyre. This index is not always shown.
7. The speed rating denotes the maximum speed at which the tyre should be used for extended periods. †
8. Tyre manufacturing standard information, which can be used for tyre recalls and other checking processes. Most of this information relates to the manufacturer, place of manufacture etc. The last four numbers are the date of manufacture. For example, if the number was 3106, the tyre was made in the 31st week of 2006.
9. M+S or M/S indicates that the tyre has been designed with some capability for mud and snow.
10. The number of plies in both the tread area, and the sidewall area, indicates how many layers of rubber coated material make up the structure of the tyre. Information is also provided on the type of materials used.

Wheels and tyres

11. Wear rate indicator. A tyre rated at 400 for example, will last twice as long as a tyre rated at 200.
12. The traction rating grades a tyre's performance when stopping on a wet road surface. The higher the grade the better the braking performance. The grades from highest to lowest are, AA, A, B, and C.
13. The maximum load which can be carried by the tyre.
14. Heat resistance grading. The tyre's resistance to heat is grade A, B, or C, with A indicating the greatest resistance to heat. This grading is provided for a correctly inflated tyre, which is being used within its speed and loading limits.
15. The maximum inflation pressure for the tyre. This pressure should not be used for normal driving.

† Speed ratings

Rating	Speed km/h (mph)
Q	160 (99)
R	170 (106)
S	180 (112)
T	190 (118)
U	200 (124)
H	210 (130)
V	240 (149)
W	270 (168)
Y	300 (186)

TYRE CARE

WARNINGS



Defective tyres are dangerous. Do not drive the vehicle if a tyre is damaged, excessively worn, or incorrectly inflated. Doing so may lead to premature tyre failure.



Avoid contaminating the tyres with vehicle fluids as they may cause damage to the tyre.



Avoid spinning the wheels. The forces released can damage the structure of the tyre and cause it to fail. Doing so may lead to premature tyre failure.



If wheel spin is unavoidable due to a loss of traction (in deep snow, for example), do not exceed the 50 km/h (30 mph) point on the speedometer. Doing so may lead to premature tyre failure.



Do not exceed the maximum pressure stated on the sidewall of the tyre. Over-inflation could cause the tyre to fail suddenly.

Tyre pressures

WARNINGS



Never drive your vehicle if the tyre pressures are incorrect. Under-inflation causes excessive flexing and uneven tyre wear. This can lead to sudden tyre failure. Over-inflation causes a harsh ride, uneven tyre wear and poor handling.



Pressure checks should only be carried out when the tyres are cold, and the vehicle has been stationary for more than three hours. A hot tyre at or below recommended cold inflation pressure is dangerously under-inflated.

Wheels and tyres

WARNINGS



If the vehicle has been parked in strong sunlight, or used in high ambient temperatures do not reduce the tyre pressures. Move the vehicle into the shade and allow the tyres to cool before re-checking the pressures.

All of the vehicle's tyres (including the spare) should be checked regularly for damage, wear and distortion. If you are in any doubt about the condition of a tyre, have it checked immediately by a tyre repair centre or your Dealer/Authorised repairer.

Checking the tyre pressures

WARNING



Tyre pressures should be checked regularly using an accurate pressure gauge, when the tyres are cold.

Failure to properly maintain your tyre pressures could increase the risk of tyre failure resulting in loss of vehicle control and personal injury.

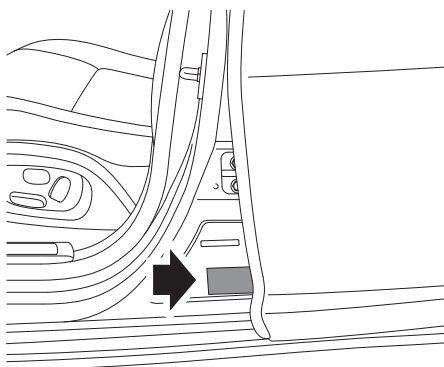

E95180

The recommended tyre pressures are listed on a placard label fixed to the end of the left-hand side door. These pressures provide optimum ride and handling characteristics for all normal operating conditions.

If winter tyres are fitted, please refer to the winter tyre pressure information. See **USING WINTER TYRES** (page 223).

In the interest of safety, reliability and fuel efficiency, check the tyres, including the spare, for condition and pressure on a weekly basis and before long journeys.

Do not check tyre pressures immediately after the vehicle has travelled in excess of 1.6 km (1.0 mile). Tyre temperatures and pressures increase when running. Deflating a warm tyre to the recommended pressure will result in under-inflation.

If tyre pressures are checked while the vehicle is inside a protected covered area, e.g. a garage, and subsequently driven in lower outdoor temperatures, tyre under-inflation could occur.

A slight pressure loss occurs naturally with time. If this exceeds 0.14 bar (2 lbf/in², 14 kPa,) per week, have the cause investigated and rectified by qualified assistance.

Tyre pressures (including the spare) should be checked at least once a week with normal on-road use, but should be checked daily if the vehicle is used off-road. Always check the tyre pressures before setting off on a long journey.

If it is necessary to check tyre pressures when the tyres are warm, you should expect the pressures to have increased by up to 0.3-0.4 bar (4-6 lbf/in², 30-40 kPa). Do not reduce the tyre pressures to the cold inflation pressure under these circumstances. Allow the tyres to cool fully before adjusting the pressures.

Wheels and tyres

The following procedure should be used to check and adjust the tyre pressures.

1. Remove the valve cap.
2. Firmly attach a tyre pressure gauge/inflator to the valve.
3. Read the tyre pressure from the gauge, and add air if required.
4. If air is added to the tyre, remove the gauge and re-attach it before reading the pressure. Failure to do so may result in an inaccurate reading.
5. If the tyre pressure is too high, remove the gauge and allow air out of the tyre by pressing the centre of the valve. Refit the gauge to the valve and check the pressure.
6. Repeat the process adding or removing air as required until the correct tyre pressure is reached.
7. Refit the valve cap.

Note: It is an offence in certain countries to drive a vehicle with incorrect tyre pressures.

Note: It is the driver's responsibility to ensure that the tyre pressures are correct.

Tyre valves

Keep the valve caps screwed down firmly to prevent water or dirt entering the valve. Check the valves for leaks when checking the tyre pressures.

Pressure compensation for ambient temperature changes

If the intended journey will take the vehicle into an area where the ambient local temperature is known to be lower than the journey start point, tyre pressure under-inflation could occur.

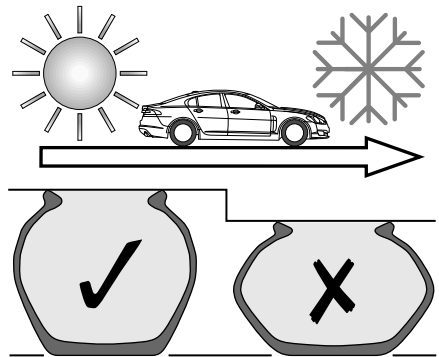

E95181

A colder ambient local temperature will reduce pressure within the tyre. An effect is to decrease sidewall height and to increase tyre shoulder wear with the potential for tyre failure. Vehicle dynamics could also be adversely affected.

In order to minimise this effect, tyre pressures can be adjusted to compensate before the start of the journey. Alternatively, tyre pressures can be adjusted when the area of lower ambient temperature is reached.

In this situation, the vehicle must be left in the ambient local temperature for a least one hour before tyre pressure is adjusted.

To compensate for colder ambient temperatures, tyre pressures should be increased by 0.14 bar (2lbf/in², 14 kPa) for each 10°C (20°F) decrease.

Note: Ensure that correct tyre pressures are maintained when moving to areas of differing ambient temperature.

The Tyre Pressure Monitoring system (TPM system) may issue a warning if the under-inflation becomes significant. When driving through variable climatic conditions the TPM system warnings may be intermittent.

Wheels and tyres

Tyre pressure compensation chart - high ambient temperatures

Tyre pressure temperature compensation	
Ambient temperature - °C (°F)	Pressure compensation - bar (lbf/in ² , kPa)
20 (68)	use placard label
30 (86)	+ 0.14 (2, 14)
40 (104)	+ 0.28 (4, 28)
50 (122)	+ 0.41 (6, 41)

Tyre pressures during long term vehicle storage

To minimise the possibility and effects of flat spots during storage, the tyres may be inflated to the maximum pressure indicated on the tyre wall.

Note: Before using the stored vehicle on the road again, ensure that correct tyre pressures are restored.

Flat spots

If the vehicle is stationary for a long period, when the ambient temperature is high, the tyres may form flat spots. When the vehicle is driven, these flat spots will cause a vibration which will steadily disappear as the tyres warm up and regain their original shape.

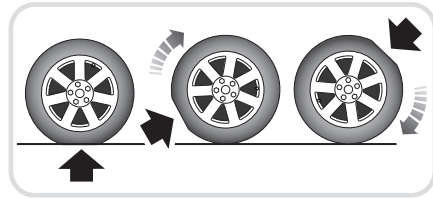

E80322

In order to minimise flat spotting, the tyre pressures can be increased. Tyre pressures should be increased by 0.14 bar/14 kPa (2 lbf/in²) for each 10°C (20°F) temperature increase above 20°C (68°F)

Long term storage

Flat spotting can be minimised during long term storage, by increasing the tyre pressures to the maximum indicated on the tyre sidewall.

Note: The tyre pressures should be reduced to the correct pressure before the vehicle is driven.

Tyre wear

Good driving practise will improve the mileage you obtain from your tyres, and avoid unnecessary damage.

- Always ensure that the tyre pressures are correctly adjusted.
- Always observe the posted speed limits, and advisory speeds for bends.
- Avoid pulling away quickly, or hard acceleration.
- Avoid making fast turns or braking sharply.
- Wherever possible, avoid potholes, or obstacles on the road.
- Do not drive up kerbs, or rub the tyres against them when parking.

Wheels and tyres

Wear indicators

WARNING



Wear indicators show the minimum tread depth recommended by the manufacturers. Tyres which have worn to this point will have reduced grip and poor water displacement characteristics.

CAUTION



If tread wear is uneven across a tyre, or the tyre wears excessively, the vehicle should be checked by your Dealer/Authorised Repairer as soon as possible.



E91698

When the tread has worn down to approximately 2 mm, wear indicators start to appear at the surface of the tread pattern. This produces a continuous band of rubber across the tread as a visual indicator.

To maintain performance and grip the tyre must be replaced as soon as the wear indicator becomes visible. Sooner, if legislation requires replacement at a greater tread depth.

Note: *Tread depth should be checked regularly, in some case more frequently than the service intervals. For advice on checking tyres contact your Dealer/Authorised repairer or a tyre dealer.*

Age degradation

Tyres degrade over time due to the effects of ultraviolet light, extreme temperatures, high loads, and environmental conditions. It is recommended that tyres are replaced at least every six years, but they may require replacement more frequently.

Jaguar recommends that even if unused, the spare tyre be replaced at the same time as the four road tyres.

Punctured tyres

WARNING



Do not drive the vehicle with a punctured tyre. Even if the punctured tyre has not deflated, it is unsafe to use, as the tyre may deflate suddenly at any time. See **TYRE REPAIR KIT** (page 229).

Tyre checks

Not all punctures result in the tyre deflating immediately. Therefore, it is important to check the tyres for damage and foreign objects, regularly.

When driving, if a sudden vibration, or change to the vehicle's handling is noticed, reduce speed immediately. Do not brake hard, or make any sudden manoeuvres or direction changes. Drive slowly to an area off the main highway and stop the vehicle.

Note: *Driving the vehicle to a safe area may cause damage to the punctured tyre, but occupant safety is far more important.*

Inspect the tyres for signs of punctures, damage or under inflation. If any damage or deformity is detected, the tyre should be replaced. If a spare tyre is not available, then the vehicle should be recovered to a tyre repair centre, or Dealer/Approved repairer.

Wheels and tyres

Replacement tyres

WARNINGS



Do not fit cross-ply tyres.



Do not fit tubed tyres.



Do not swap tyres around the vehicle. Tyres bed in to the specific characteristics of each wheel position. Swapping them around may affect the vehicle's handling and traction.



Always fit replacement tyres of the same type, and wherever possible of the same make and tread pattern.



Replacement wheels should be genuine Jaguar parts. This will maintain the designed driving characteristics.



If the use of tyres not recommended by Jaguar is unavoidable, ensure that you read, and fully comply with, the tyre manufacturers instructions. Failure to do so, may lead to tyre failure due to incorrect fitment or use.

Ideally, tyres should be replaced in sets of four. If this is not possible, replace the tyres in pairs (front and rear). When tyres are replaced, the wheels should always be re-balanced and alignment checked.

The correct tyre specification for your vehicle can be found on the tyre information label.

Directional tyres

Directional tyres are designed to operate correctly when rotating forwards (when the vehicle is travelling forwards).

Typical direction indicators

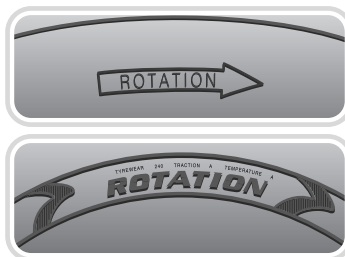

E95182

Wheels and tyres

USING WINTER TYRES

Winter tyres are more suitable during extremes of low temperatures, snow and ice and will considerably improve the vehicle's handling during these conditions.

Do not exceed 240 km/h (150 mph) when using Jaguar approved winter tyres.

Winter tyres must be fitted to all four wheels.



CAUTION

- ! Tyres with an all season icon or **M+S** have a level of winter performance and need not be replaced.

Approved winter tyre sizes

Front:

- Dunlop Wintersport M3 - 235/55R17 99H, 245/45R18 96V, 245/45R18 100V, 245/40R19 98V.
- W240 Pirelli Sotto Zero - 245/45R18 100V, 245/40R19 98V, 255/35R20 97V

Rear:

- Dunlop Wintersport M3 - 235/55R17 99H, 245/45R18 96V, 245/45R18 100V, 245/40R19 98V.
- W240 Pirelli Sotto Zero - 245/45R18 100V, 245/40R19 98V, 285/30R20 99V

Winter tyre pressures

Up to 240 km/h (150 mph)	
Front	2.0 bar (30 lbf/in ² , 207 kPa)
Rear	2.3 bar (33 lbf/in ² , 230 kPa)

USING SNOW CHAINS

CAUTION

- ! It is essential that only snow chains of the recommended type are fitted, other snow chains may cause damage to the vehicle.

Snow chains, of the recommended type, can only be fitted to rear wheels. They should not be used on temporary use spare wheels.

You should contact your Dealer/Authorised Repairer for details and availability of approved snow chains.

The maximum speed when using snow chains is 50 km/h (30 mph).

Remove the snow chains immediately the roads are clear of snow.

Ensure the fitting instructions supplied with the snow chains are kept in a safe place, for example, with this literature pack.

Note: When using snow chains, select JaguarDrive Control Winter mode with DSC switched on.

Wheels and tyres

RUN FLAT TYRES

WARNING



If a run-flat tyre is deflated, maximum vehicle speed must not exceed 80 km/h (50 mph).



Run-flat tyres can be identified by the lettering **RSC** on the sidewall. The tyre construction utilises a specially reinforced sidewall, which allows the vehicle to be driven at restricted speeds, even when the tyre is depressurised. Run-flat tyres can only be fitted to special rims, constructed for run-flat tyre use.

A tyre pressure monitoring system is mandatory when the vehicle is fitted with run-flat tyres. See **TYRE PRESSURE MONITORING SYSTEM** (page 234).

If the tyre has deflated, the vehicle should be driven with caution, as handling characteristics will be different compared to a fully inflated tyre.

If the vehicle is fully laden with passengers and luggage, the maximum distance that can be completed on a fully deflated tyre, is approximately 80 kilometres (50 miles).

Stop immediately if the tyre construction begins to break down or if the tyre dislodges from the wheel rim. Typically, this will be accompanied by excessive vibration.

A tyre driven in a deflated condition must be replaced as soon as possible.

Vehicles fitted with run-flat tyres are not fitted with a spare wheel or jacking equipment. Therefore, run-flat tyres should be replaced with the same type of tyre.

TOOL KIT

Tool kit contents

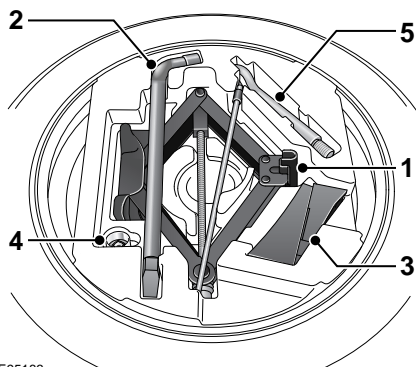

E95183

1. Jack.
2. Wheel brace.
3. Chock.
4. Locking wheel nut adaptor.
5. Towing eye.

WARNING



After use, the tool kit should be returned to the under floor storage area and correctly stowed. Do not leave the tool kit or its components loose in the storage area, as they can prove hazardous during an impact or sudden manoeuvre.

Note: When returning the tool kit to its stowage position, hook the T-bar of the clamp over the jack handle, to secure in position.

Note: The jack requires occasional maintenance. Examine the jack for wear, damage or corrosion and lubricate the moving parts.

Wheels and tyres

CHANGING A ROAD WHEEL

WARNINGS



Always ensure replacement tyres have the correct rating and specifications (e.g. load index, size, speed rating) for your vehicle.



When using tyres other than those recommended by Jaguar, do not exceed the speed capacity recommended by the manufacturer.



Wheels are extremely heavy. Take care when lifting and particularly when removing and replacing a wheel

in its storage position in the luggage compartment.

If a wheel change is required, pull off the road completely. Park on ground which is as level and solid as possible. Ensure that the vehicle is clear of any objects that will obstruct the safe removal of the wheel. Switch on hazard warning lamps and, where legally required, display the warning triangle.

Regular maintenance of tyres contributes not only to safety, but to the designed function of the vehicle. Road-holding, steering and braking are especially vulnerable to incorrectly pressurised, badly fitted or worn tyres.

Tyres of the correct size and type, but of different make can have widely varying characteristics. It is therefore recommended that Jaguar approved tyres are fitted to all wheels.

CAUTION



Ultra high performance tyres. This vehicle is equipped with an Ultra High Performance (UHP) tyre and wheel combination designed to give maximum dry road performance with consideration for aquaplaning resistance. UHP tyres have performance enhancing soft rubber tread compound. If driven aggressively they may suffer rapid tread wear and a shorter life than can be expected from other tyre types. This wheel and tyre combination is more susceptible to damage from road hazards.

Do not use this combination for driving on snow or ice. High performance tyres must be replaced with winter tyres when weather conditions dictate.

Temporary use spare wheel

Observe the following warnings before using the wheel:

WARNINGS



Note the temporary use spare wheel warning label. Adhere to instructions on the label. Failure to comply can be dangerous.



When a temporary use spare wheel is fitted, drive with caution and replace with the specified wheel and tyre as soon as possible.



Do not fit more than one temporary use spare wheel and tyre assembly at one time.



The temporary use spare wheel must be inflated to 4.2 bar (60 lbf/in², 420 kPa) and cannot be repaired.



Temporary use spare wheel, maximum speed is 80 km/h (50 mph).

Wheels and tyres

WARNINGS



If the vehicle is fitted with Tyre Pressure Monitoring System (TPM System). See **TYRE PRESSURE MONITORING SYSTEM** (page 234).



DSC must be **on** when the temporary use spare wheel is in use.

Locking wheel nuts

Vehicles may be equipped with a locking wheel nut on each wheel. These are similar to standard wheel nuts, and can only be removed using the special adaptor provided with the jacking equipment.

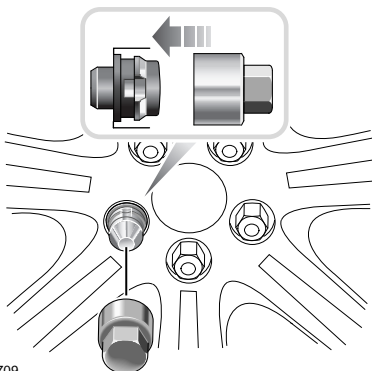

E91709

1. Insert the adaptor firmly onto the locking wheel nut.
2. Using the wheel brace, unscrew the wheel nut and adaptor.
3. Return the locking wheel nut adaptor to the correct storage position.

Note: A code number is stamped on the side of the locking nut. Ensure the number is recorded on the Security Card supplied with the literature pack. Quote this number if a replacement is required. Do not keep the Security Card in the vehicle.

Spare wheel location

The spare wheel and jacking tools are stored under the luggage compartment floor panel.

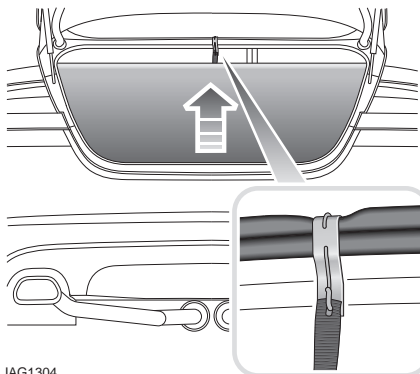

JAG1304

To remove the spare wheel: Raise the luggage compartment floor panel, hooking the strap over the upper boot seal as illustrated.

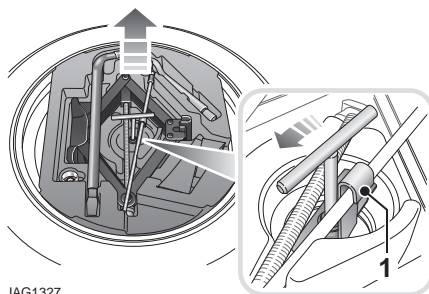

JAG1327

Unscrew the Tee bolt, releasing the retaining clamp and hook.

Remove the tool tray from the spare wheel and remove the spare wheel from the luggage compartment.

Remove the jack and wheel nut wrench from the tray.

Note: When refitting the Tee bolt, ensure that the retaining hook (1) fits over the jack handle, as illustrated.

Wheels and tyres

Wheel changing safety

Before raising the vehicle, or changing a wheel ensure that you read, and comply with the following warnings.

WARNINGS



Always find a safe place to stop, off the highway and away from traffic.



Ensure that the vehicle is on firm level ground.



Disconnect trailer/caravan from vehicle.



Switch on the hazard warning lamps.



Ensure that all passengers, and animals, are out of the vehicle and in a safe place away from the highway.



Place a warning triangle at a suitable distance behind the vehicle, facing towards oncoming traffic.



Ensure that the front wheels are in the straight ahead position, and engage the steering lock.



Apply the parking brake, and engage Park (P).



Ensure that the jack is on firm level ground.



Never place anything between the jack and the ground, or the jack and the vehicle.



When one rear wheel is lifted off the ground the selection **P** (Park) position will not prevent the vehicle from moving and possibly slipping off the jack as the park brake only operates on the rear wheels.



Do not start or run the engine while the vehicle is supported only by a jack.

WARNINGS



The jack is designed for use when changing a wheel only. Never work beneath the vehicle with the jack as the only means of support - use vehicle support stands.



Always chock the wheel diagonally opposite the wheel to be changed, using the wheel chock supplied in the tool kit. Chock the front of a front wheel, or the rear of a rear wheel.



If jacking the vehicle on a slight slope is unavoidable, place chocks on the downhill side of the two opposite wheels. An additional chock will be needed.



Take care when lifting the spare wheel, and removing the punctured wheel. The wheels are heavy, and can cause injuries if not handled correctly.



Remove the spare wheel prior to jacking the vehicle. To avoid destabilising the vehicle when raised.



Take care when loosening the wheel nuts. The wheel brace may slip off if not properly attached, and the wheel nuts may give way suddenly. Either unexpected movement may cause an injury.

Wheels and tyres

Wheel changing procedure

WARNINGS



Do not attempt to lift the vehicle unless the jack head is fully engaged in the jacking point.



Ensure that the park brake is applied.

CAUTION



Ensure before raising the vehicle that the jack is correctly positioned to avoid any damage to the vehicle sills or sill panels.

1. Ensure that all passengers are in a safe place, clear of the vehicle.
2. Apply the parking brake and select gear position **P** (Park).
3. Ensure that the jack is placed on firm and level ground.

Observe the instructions printed on the jack.

Use the jack only for lifting the vehicle during wheel changing and only use the jack which is stored in the vehicle.

Before raising the vehicle slacken but do not remove the wheel nuts.

There are four jacking points on the underside of the floor. Two indented, triangular indicators are provided on each sill cover. These indicate the location for the jack.

The simplest way to correctly locate the jacking point is to feel along the sill panel to the triangular indentation and then fit the jack to the body, not to the sill panel.

Carefully raise the vehicle by turning the jack handle. Stop jacking the vehicle when the tyre just clears the ground. Minimum tyre lift gives maximum vehicle stability.

Remove the wheel nuts and the wheel.

To remove the centre badge use the plastic tipped end of the wheel nut wrench handle, push the centre badge from its housing from the inside of the wheel.

Push the centre badge into the replacement wheel. If the temporary use spare wheel is to be fitted, keep the centre badge safely and fit it to the repaired full size wheel when it has been refitted.

Fit the spare wheel and loosely secure with the wheel nuts.

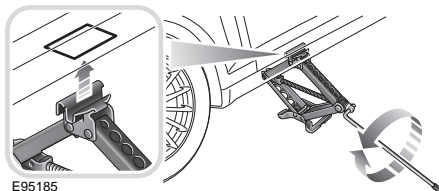
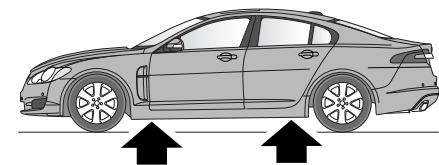

E95185

Wheels and tyres

Tightening the wheel nuts

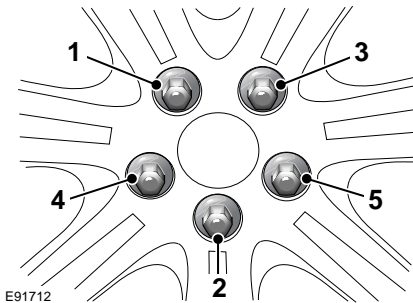

Using the wheel nut wrench, lightly tighten the wheel nuts alternately using the sequence shown in the illustration.

Lower the jack and tighten the wheel nuts alternately. Do not overtighten by using foot pressure or extension bars on the wheel nut wrench.

At the earliest opportunity have the wheel nuts tightened with a torque wrench to 125 Nm (92 lb.ft).

This torque must not be exceeded.

TYRE REPAIR KIT

WARNINGS



To ensure vehicle safety, it is essential that you read and understand the following information.

Failure to follow the instructions given here, may lead to serious tyre damage and may result in death or serious injury.



If you are in any doubt regarding your ability to carry out the instructions, contact your Dealer/Approved Repairer before attempting the repair.

Your vehicle may not be equipped with a spare tyre. If this is the case, in its place in the rear underfloor storage compartment, you will find a Jaguar tyre repair kit (except where run-flat tyres are fitted). The Jaguar tyre repair kit can be used to repair **one** tyre and it is essential that you read the following guide before attempting to repair a tyre.

The Jaguar tyre repair kit seals most punctures caused by nails, or similar items, with a maximum diameter of 6 mm (1/4 inch).

Note: *The sealant used in the tyre repair kit has a shelf life and the expiry date is shown on the tyre sealant bottle. Ensure that the container is replaced before the expiry date.*

Wheels and tyres

Jaguar tyre repair kit safety information

WARNINGS

 Some tyre damage may only be partially sealed, or may not seal at all, depending on the amount and type of damage. Any loss of tyre pressure can seriously affect vehicle safety.

 Do not use the tyre repair kit if the tyre has been damaged by driving while under-inflated.

 Only use the tyre repair kit to seal damage located within the tyre tread area.

 Do not use the tyre repair kit to seal damage to the tyre sidewall.

 Do not exceed 80 km/h (50 mph) when a repaired tyre is fitted to the vehicle.

 The maximum distance that should be driven when a repaired tyre is fitted, is 200 km (125 miles).

 When a repaired tyre is fitted, drive with caution and avoid sudden braking or steering manoeuvres.

 Only use the tyre repair kit for the vehicle with which it was supplied.

 Do not use the tyre repair kit for any other purpose than tyre repair.

 Never leave the tyre repair kit unattended when in use.

 Only use the tyre repair kit within the -30 °C to +70 °C temperature range.

 Always keep children and animals at a safe distance from the tyre repair kit when in use.

 Do not stand directly beside the compressor when it is operating.

WARNINGS

 Check the tyre sidewall prior to inflation. If any cracks, damage or deformities are apparent, do not inflate the tyre.

 Watch the tyre sidewall during inflation. If any cracks, bumps or similar damage, or deformities appear, switch off the compressor and deflate the tyre.

Wheels and tyres

Jaguar tyre repair kit

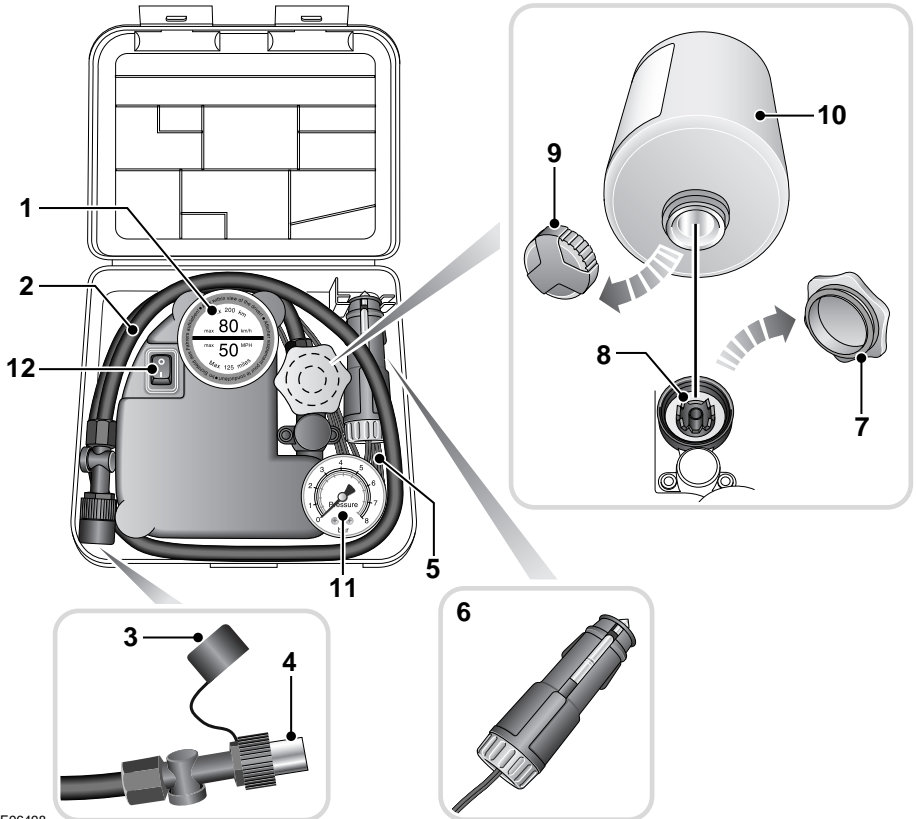

E96498

1. Maximum speed label. 80 km/h (50 mph).
2. Tyre inflation hose.
3. Inflation hose protective cap.
4. Inflation hose connector.
5. Compressor power cable.
6. Power cable connector.
7. Sealant bottle receiver cap (orange).
8. Sealant bottle receiver.
9. Sealant bottle cap.
10. Sealant bottle.
11. Tyre pressure gauge.
12. Compressor on/off switch (I = on. 0 = off.).

Wheels and tyres

Using the Jaguar tyre repair kit

WARNINGS



Avoid skin contact with the sealant which contains natural rubber latex.



If the tyre inflation pressure does not reach 1.8 bar (26 lbf/in², 180 kPa) within seven minutes, the tyre may have suffered excessive damage. A temporary repair will not be possible, and the vehicle should not be driven until the tyre has been replaced.

CAUTIONS



Before attempting a tyre repair, ensure that the vehicle is parked safely, as far away from passing traffic as possible.



Ensure that the parking brake is applied and **P** (Park) is selected.



Do not attempt to remove foreign objects such as nails, screws, etc. from the tyre.



Always run the engine when using the compressor, unless the vehicle is in an enclosed or poorly ventilated space, as this may cause asphyxiation.



To prevent overheating, do not operate the compressor continuously for longer than ten minutes.

Note: All vehicle drivers and occupants should be made aware that a temporary repair has been made to a tyre fitted to the vehicle. They should also be made aware of the special driving conditions imposed when using a repaired tyre.

Repair procedure

WARNING



Check the tyre sidewall prior to inflation. If there are any cracks, bumps or similar damage, do not attempt to inflate the tyre. Do not stand directly beside the tyre while the compressor is pumping. Watch the tyre sidewall. If any cracks, bumps or similar damage appear, turn off the compressor and let the air out by means of the pressure relief valve. Do not continue to use the tyre.

1. Open the tyre repair kit and peel off the maximum speed label. Attach the label to the fascia in the driver's field of vision. Take care not to obstruct any of the instruments or warning lights.
2. Uncoil the compressor power cable and the inflation hose.
3. Unscrew the orange cap from the sealant bottle receiver and the sealant bottle cap.
4. Screw the sealant bottle into the receiver (clockwise) until tight.
 - Screwing the bottle onto the receiver will pierce the bottle's seal. Do not unscrew a full, or partly used bottle from the receiver. Doing so will result in sealant leaking from the bottle.
5. Remove the valve cap from the damaged tyre.
6. Remove the protective cap from the inflation hose and connect the inflation hose to the tyre valve. Ensure that the hose is screwed on firmly.
7. Ensure that the compressor switch is in the off (**0**) position.
8. Insert the power cable connector into the auxiliary power socket. See **AUXILIARY POWER SOCKETS** (page 125).

Wheels and tyres

9. Unless the vehicle is in an enclosed area, start the engine.
10. Set the compressor switch to the on (I) position.
11. Inflate the tyre to a minimum of 1.9 bar (26 lbf/in²) and a maximum of 3.5 bar (51 lbf/in²).
 - When pumping the sealant through the tyre valve, the pressure may rise up to 6 bar (87 lbf/in²). The pressure will drop again after approximately 30 seconds.
12. During the inflation, switch the compressor off briefly, to check the tyre pressure using the gauge mounted on the compressor.
 - It should not take longer than seven minutes to inflate the tyre. If, after seven minutes, the tyre has not yet reached minimum pressure, the tyre should not be used.
13. Once the tyre has been inflated, switch off the compressor. If desired, the engine may be turned off after the compressor has been turned off.
14. Remove the power connector from the auxiliary power socket.
15. Remove the inflation hose from the tyre valve, by unscrewing it as quickly as possible (counter-clockwise).
16. Replace the inflation hose protective cap and the tyre valve cap.
17. Do not remove the sealant bottle from the receiver.
18. Ensure that the tyre repair kit (including the bottle and receiver caps) are placed securely in the vehicle. You will need to use the kit to check the tyre pressure after approximately 3 km (2 miles), so ensure they are easily accessible.

19. Immediately drive the vehicle for approximately 3 km (2 miles), to allow the sealant to coat the inner surface of the tyre and form a seal at the puncture.

Checking the tyre pressure after a repair

WARNINGS



When driving the vehicle, if you experience vibrations, abnormal steering, or noises, reduce speed immediately. Drive with extreme caution and reduced speed, to the first safe place to stop the vehicle. Visually examine the tyre and check its pressure. If there are any signs of damage or deformity to the tyre, or the tyre pressure is below 1.3 bar (19 lb/in²), do not continue driving.



Consult a tyre repair centre or your Dealer/Authorised Repairer, for advice concerning the replacement of a tyre after using a tyre repair kit.

1. Drive the vehicle for 3 km (2 miles) then stop in a safe place. Carry out a visual examination of the tyres condition.
2. Make sure that the sealant container section is in its original position.
3. Screw the inflation hose connector firmly onto the tyre valve.
4. Read the tyre pressure from the gauge.
5. If the pressure of the sealant filled tyre is above 1.3 bar (19 lb/in²) adjust the pressure to the correct value. See **TYRE CARE** (page 217).
6. Ensure that the compressor switch is in the off (O) position and insert the power cable connector into the auxiliary power socket.

If the vehicle is in a well ventilated area, start the engine.

Wheels and tyres

7. Switch the compressor to on (I) and inflate the tyre to the correct pressure.
8. To check the tyre pressure, turn off the compressor then read the pressure from the gauge.
9. When the compressor is off, if the tyre pressure is too high, release the required amount of pressure using the pressure relief valve.
10. Once the tyre is inflated to the correct pressure, switch off the compressor and remove the power plug from the auxiliary socket.
 - The use of the tyre repair kit sealant may lead to error prompts and incorrect readings of the Tyre Pressure Monitoring System. Therefore, use the tyre repair kit pressure gauge to check and adjust the damaged tyre's inflation pressure.
11. Unscrew the inflation hose connector from the tyre valve, replace the tyre valve cap and the inflation hose connector protective cap.
12. Ensure that the tyre repair kit is placed securely in the vehicle.
13. Drive to the nearest tyre repair centre or Dealer/Authorised Repairer, for a replacement tyre to be fitted. Ensure that you make the repair centre aware that the tyre repair kit has been used before the tyre is removed.
14. Both the tyre inflation hose, and the sealant container should be replaced once a new tyre has been fitted.



Only sealant containers which are completely empty should be disposed of with normal household waste. Sealant containers which contain some sealant, and the tyre inflation hose, should be disposed of by a tyre specialist or your Dealer/Authorised Repairer, in compliance with local waste disposal regulations.

TYRE PRESSURE MONITORING SYSTEM

WARNINGS



The Tyre Pressure Monitoring (TPM) system is NOT a substitute for manually checking tyre pressures.

The TPM system only provides a low pressure warning and does not re-inflate your tyres. Tyre pressures should be checked regularly using an accurate pressure gauge when cold. Failure to properly maintain your pressures could increase the risk of tyre failure, with consequential loss of vehicle control and personal injury.



The TPM system can NOT register damage to a tyre. Regularly check the condition of your tyres, especially if the vehicle is driven off-road.

CAUTION



When inflating tyres, care should be taken to avoid bending or damaging the TPM system valves. Always ensure correct alignment of the inflation head to the valve stem.

Note: *Non-approved accessories may interfere with the system. If this occurs, **TYRE PRESSURE SYSTEM FAULT** is displayed in the message centre.*

Wheels and tyres

Note: Different types of tyre may affect the performance of the TPM system. Always replace tyres in accordance with recommendations. See **TYRE SPECIFICATIONS - ARDUOUS TERRAIN** (page 239).

Your vehicle may be equipped with a TPM System which monitors pressure in each tyre (temporary use spare wheels are not fitted with sensors and are consequently not monitored).

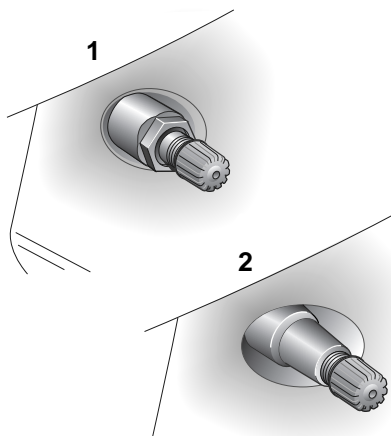

E91713

Wheels fitted with a TPM system can be easily visually identified by the external metal lock nut and valve (1). All Jaguar non-TPM system wheels have a rubber valve fitted (2).

TPM system operation

The TPM system monitors pressure of the tyres via sensors located in each wheel and a receiver located within the vehicle.

Communication between sensor and receiver is via Radio Frequency (RF) signals.



The tyre pressure warning comprises a yellow warning telltale within the instrument panel, and the associated messages within the message centre.

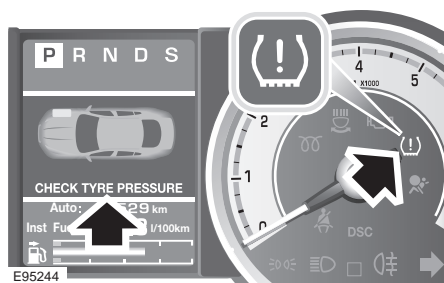

If the telltale light illuminates, you should stop and check your tyres as soon as possible and inflate them to the recommended pressure as stated on the tyre pressure placard. If low pressure warnings occur frequently, the cause must be determined and rectified.

When driving through variable climatic conditions the TPM system warnings may be intermittent.

Your vehicle will also indicate a TPM System malfunction by initially flashing and subsequent continuous illumination of the warning telltale. A text message will accompany the system malfunction and will display **TYRE PRESSURE SYSTEM FAULT**. The TPM system fault sequence will be activated at every ignition cycle until the fault is rectified. When a malfunction occurs, the system may not be able to detect or signal low tyre pressure as intended.

TPM system malfunctions may occur for a variety of reasons which may include other radio frequency systems that could cause interference or the installation of incompatible replacement tyres on the vehicle.

Wheels and tyres

Tyre pressure warning with speed

If the vehicle is to be driven at speeds in excess of 160 km/h (100 mph), the tyre pressures should be increased as stated in this handbook or on the placard label. Failure to increase the tyre pressures and driving in excess of 160 km/h (100 mph), will illuminate the yellow warning telltale and display a text message **TYRE PRESSURES LOW FOR SPEED**. In the event of this warning being displayed, vehicle speed should be reduced

Temporary use spare wheel and tyre change

If the temporary use spare wheel is fitted the system will automatically recognise the change in wheel positions. Then after approximately ten minutes of driving above 25 km/h (18 mph), a message **TYRE NOT MONITORED** will be displayed accompanied by illumination of the warning telltale and the corresponding block in the vehicle graphic.

The warning telltale will initially flash and will subsequently revert to continuous illumination. Extended use of the temporary use spare wheel will produce an additional text message **TYRE PRESSURE SYSTEM FAULT**.

This TPM system display sequence will be activated at every ignition cycle until the temporary use spare wheel is replaced by a fully operational full size wheel and tyre assembly.

Always replace the temporary use wheel before having TPM system faults investigated. The fault may well be rectified with the fitment of a fully operational full size running tyre in lieu of the temporary use spare wheel assembly.

Tyre changing

Always have your tyres serviced or changed by a qualified engineer.

Care must be taken to avoid contact between the bead of the tyre and the sensor during removal and refitting of the tyre, otherwise the sensor may become damaged and or inoperable.

CAUTION



Valve stem seal, washer, nut, valve core and cap should be replaced at every tyre change. Valve stem seal, washer and nut must be replaced if valve retention nut is loosened. Sensor units and nuts must be refitted using correct torque figures and associated profile. Damage to the vehicle may result if these precautions are not taken.

Sensors can be removed from the wheel by the unscrewing of the valve retention nut.

Replacement sensor

Should the sensor require replacing, it should be carried out by a Dealer/Authorised Repairer.

A replacement sensor must be fitted to a running wheel in order to be recognised by the system. The vehicle needs to be stationary for 15 minutes during the sensor fitment before the system is ready to detect the new sensor. The vehicle must be driven for a minimum of fifteen minutes after the sensor change, and then remain stationary for fifteen minutes to activate full TPM system operation.

If the TPM system warning for any wheel does not clear, even after ensuring correct inflation and driving for more than ten minutes above 25 km/h (18 mph), you should seek qualified assistance as soon as possible.

Wheels and tyres

TPM System information messages

Message	Warning Indicator	Priority Indicator	Meaning
CHECK TYRE PRESSURE (Graphic indication displays which tyre is under-inflated.)	TPM System	Amber	You should as soon as possible stop, check your tyre and inflate them to the recommended pressure.
CHECK ALL TYRE PRESSURES	TPM System	Amber	May be displayed when the vehicle is learning that a new sensor is fitted to the vehicle and one or more tyres has low pressure. You should as soon as possible stop, check your tyres and inflate them to the recommended pressure.
TYRE PRESSURE SYSTEM FAULT	TPM System	Amber	1. The wheels do not have TPM System sensors fitted. 2. The TPM System sensors have become defective, an unapproved accessory is interfering with the system or a general fault has been detected. Seek qualified assistance as soon as possible.
TYRE NOT MONITORED (Graphic indication displays which tyre is not monitored.)	TPM System	Red	1. A temporary use spare wheel is fitted. Vehicle speed should be limited to 80 km/h (50 mph). 2. A TPM System sensor has become defective, an unapproved accessory is interfering with the system or a wheel has been fitted that does not have a sensor. Seek qualified assistance as soon as possible.
TYRE PRESSURES LOW FOR SPEED	TPM System	Amber	The tyre pressures are not suitable for high speed driving. You should reduce vehicle speed and inflate the tyres to recommended pressures for high speed driving.

Wheels and tyres

TYRE GLOSSARY

lbf/in² or psi

Pounds per square inch, an imperial unit of measure for pressure.

kPa

Kilo Pascal, a metric unit of measure for pressure.

Cold tyre pressure

The air pressure in a tyre which has been standing in excess of three hours, or driven for less than 1.6 km (1 mile).

Maximum inflation pressure

The maximum pressure to which the tyre should be inflated. This pressure is given on the tyre side wall in lbf/in² (psi) and kPa.

Note: This pressure is the maximum allowed by the tyre manufacturer. It is not the pressure recommended for use.

Kerb weight

The weight of a standard vehicle, including a full tank of fuel, any optional equipment fitted, and with the correct coolant and oil levels.

Gross vehicle weight

The maximum permissible weight of a vehicle with driver, passengers, load, luggage, equipment, and towbar load.

Accessory weight

The combined weight (in excess of those items replaced) of items available as factory installed equipment.

Production options weight

The combined weight of options installed which weigh in excess of 1.4 kg (3 lb) more than the standard items that they replaced, and are not already considered in kerb or accessory weights. Items such as heavy duty brakes, high capacity battery, special trim etc.

Vehicle capacity weight

The number of seats multiplied by 68 kg (150 lb) plus the rated amount of load/luggage.

Maximum loaded vehicle weight

The sum of kerb weight, accessory weight, vehicle capacity weight, plus any production option weights.

Rim

The metal support for a tyre, or tyre and tube, upon which the tyre beads are seated.

Bead

The inner edge of a tyre that is shaped to fit to the rim and form an air tight seal. The bead is constructed of steel wires which are wrapped, or reinforced, by the ply cords.

Wheels and tyres

TYRE SPECIFICATIONS - ARDUOUS TERRAIN

In certain markets, due to the possibility of very uneven or unmetalled roads, it is necessary to fit tyres suitable for the conditions. These markets and the relevant tyre specification are detailed below.

The following chart details the tyres recommended for use in the countries listed below:

- A.** Australia, Bahrain, Egypt, Israel, Jordan, Kuwait, Lebanon, Malaysia, Mexico, Morocco, Oman, Qatar, Saudi Arabia, South Africa, Syria, Thailand, United Arab Emirates.
- B.** Argentina, Belarus, Brazil, Bulgaria, Chile, Dominican Republic, Estonia, Guatemala, Indonesia, Kazakhstan, Panama, Philippines, Russia, Sri Lanka, Ukraine, Uzbekistan.

Wheel position	Tyre size	Pattern	A	B
Front and rear	235/55R17 99W	Pirelli P7	No	No
Front and rear	245/45R18 100Y X/L	Pirelli PZero Asymmetric	Yes	Yes
Front and rear	245/45R18 100W X/L	Dunlop Sport 01 Asymmetric	Yes	Yes
Front and rear	245/40R19 98Y X/L	Dunlop Sport 01 Asymmetric	Yes	Yes
Front	255/35R20 97Y X/L	Pirelli PZero Asymmetric	Yes	Yes
Rear	285/30R20 99Y X/L	Pirelli PZero Asymmetric	Yes	Yes
Temporary use spare wheel (front and rear):				
Alloy 4J x 18	T135/80R18	Pirelli		

For all other countries you should refer to your local Dealer/Authorised Repairer for specific tyre fitment.

Wheels and tyres

Accessory wheels and tyres



1 _____ 2 _____

3 _____

E95187

1. Front tyre pressure.
2. Rear tyre pressure.
3. Wheel and tyre information (size, speed rating, etc.).

Note: Use the table above to record accessory wheel and tyre information.

WARNING



Contact your Dealer/Authorised Repairer before fitting any accessory wheels and tyres. Your Dealer/Authorised Repairer will be able to

offer guidance regarding the correct accessories. Fitting incorrect wheel/tyre combinations can seriously affect the ride and handling of your vehicle. In extreme cases, this may lead to loss of control of the vehicle.
